

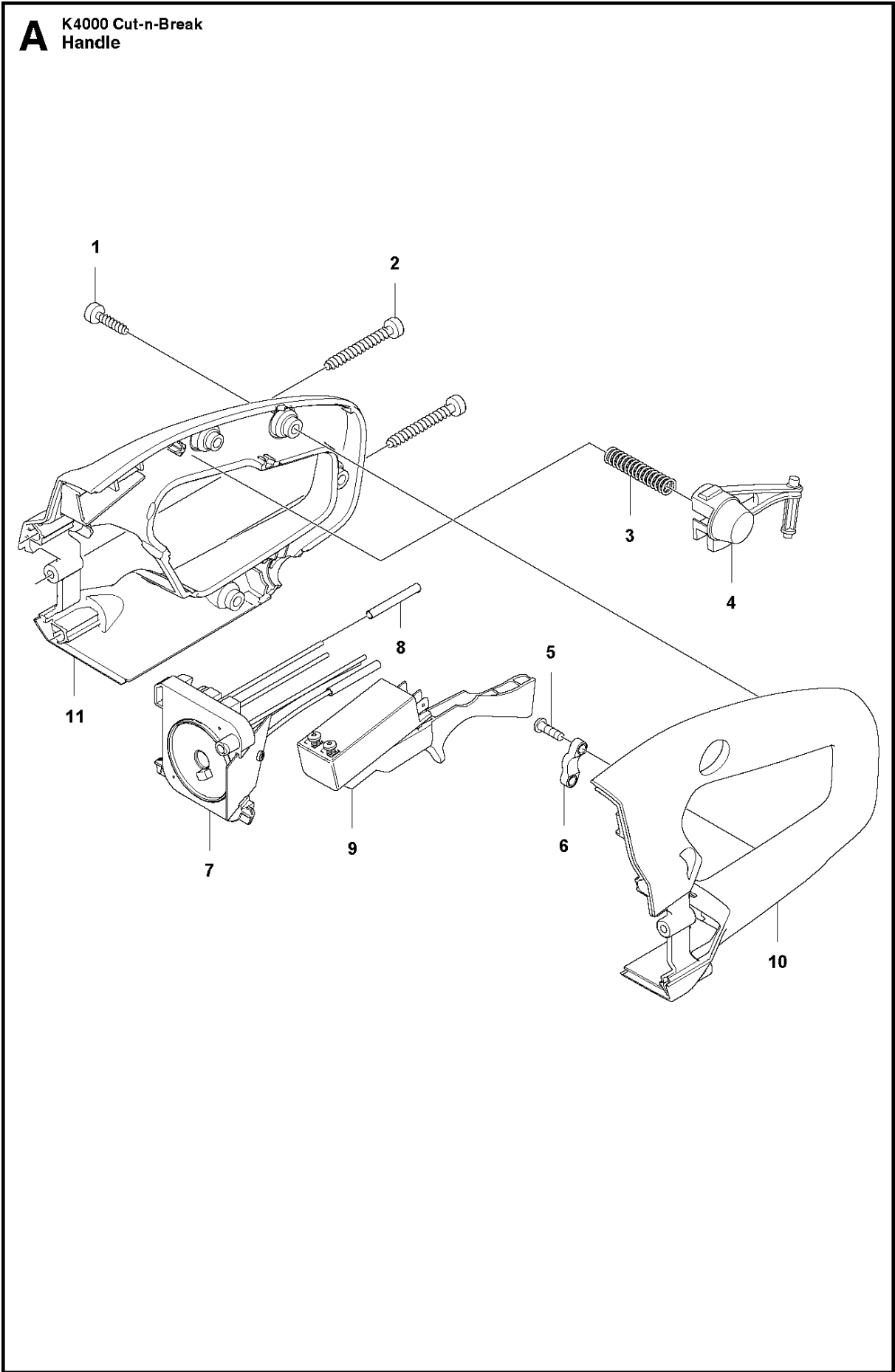

# SPARE PARTS LIST

## POWER CUTTERS

K 4000 Cut-n-Break, 2018-02



## HANDLE

K 4000 Cut-n-Break, 2018-02

Ref	Part No	Description	Remark	QTY KIT
1	589 53 01-01	SCREW ITXSCT		4
2	589 58 33-01	SCREW		4
3	577 48 19-01	SPRING		1
4	589 65 73-02	LOCKING BUTTON		1
5	590 93 57-01	SCREW		2
6	531 03 18-87	CLIP		1
7	577 01 01-05	HOLDER ASSY	100-120V, incl 8	1
7	577 01 01-06	HOLDER ASSY	230V, incl 8	1
8	578 03 26-01	SLEEVE	100-120V	1
8	578 03 24-01	SLEEVE	230V	2
9	531 03 18-83	SWITCH		1
10	582 33 02-01	HANDLE HALF		1
11	582 33 03-01	HANDLE HALF		1

**B** K4000 Cut-n-Break  
MOTOR

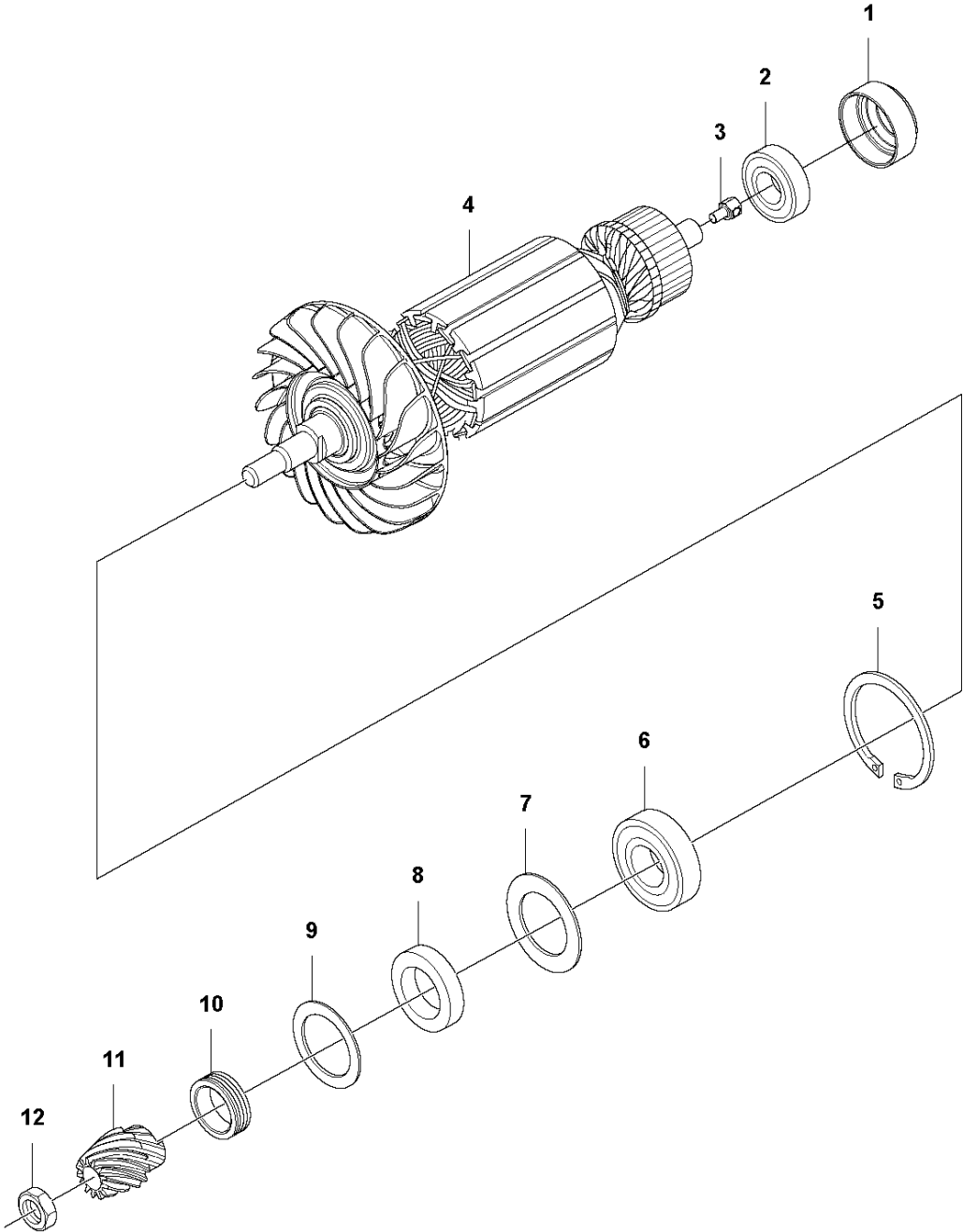

## MOTOR

K 4000 Cut-n-Break, 2018-02

Ref	Part No	Description	Remark	QTY KIT
1	577 06 66-01	RUBBER BUSHING		1
2	503 25 09-01	BEARING		1
3	579 25 62-01	SCREW		1
4	582 58 66-02	ROTOR	100-120V	1
4	582 58 66-01	ROTOR	230V	1
5	735 31 33-10	CIRCLIP		1
6	531 07 39-44	BALL BEARING		1
7	505 53 03-16	SPACER		1
8	505 53 03-41	GASKET		1
9	505 53 03-52	SPACER		1
10	505 53 03-19	SPACER		1
11	505 45 41-01	PINION		1
12	523 12 24-02	NUT		1

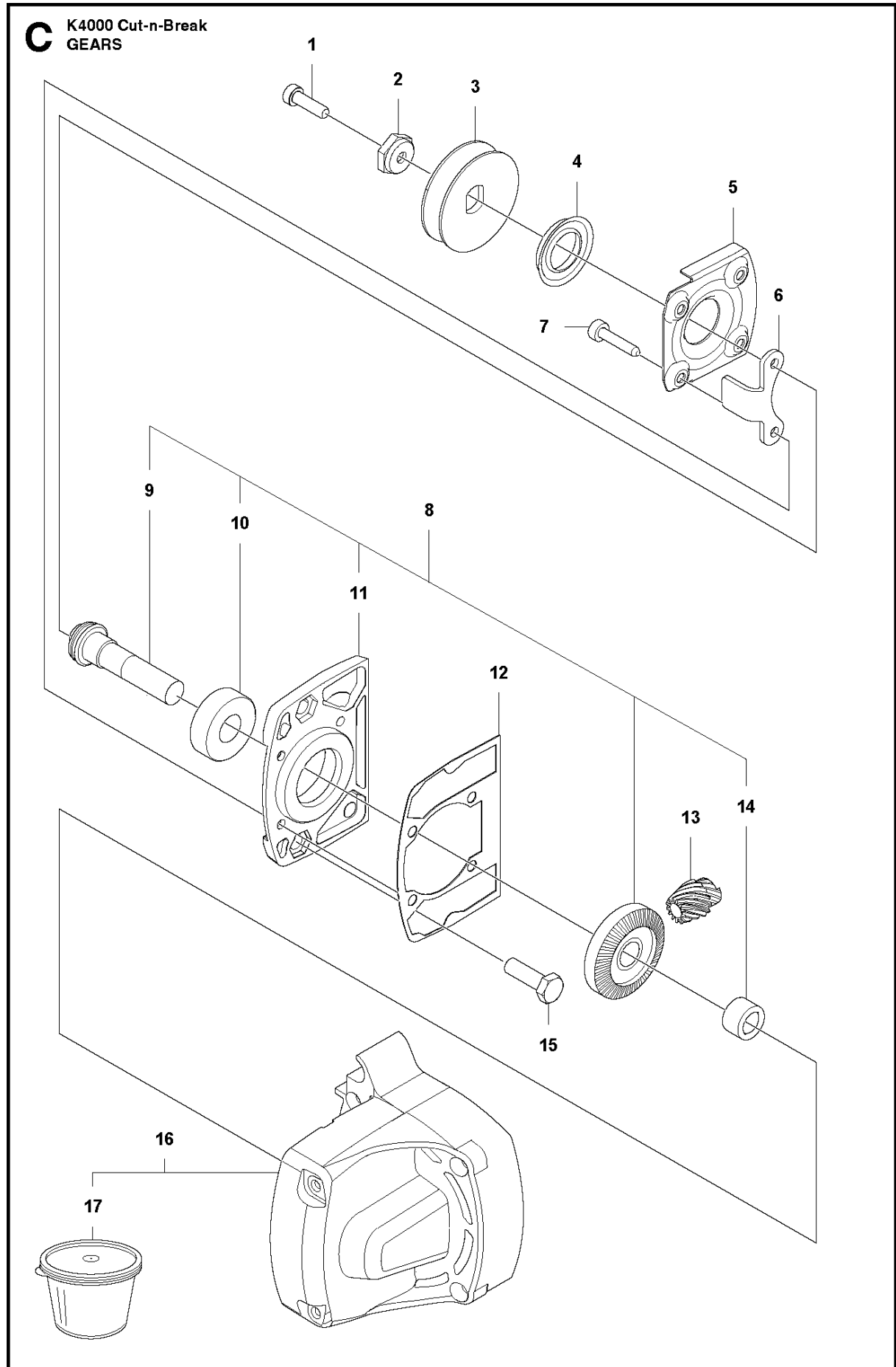

## GEARS

K 4000 Cut-n-Break, 2018-02

Ref	Part No	Description	Remark	QTY KIT
1	544 21 84-20	SCREW ITXSCM		1
2	504 03 83-01	SPACING SLEEVE		1
3	544 43 39-01	DRIVING PULLEY		1
4	506 32 06-01	SEALING		1
5	544 43 41-01	FLANGE		1
6	544 43 37-01	BRACKET		1
7	503 21 53-25	SCREW ITXSCM		4
8	544 42 66-01	GEAR SET	Incl. 9 - 11	1
9	544 42 64-01	GEAR WHEEL SHAFT		1
10	583 95 33-01	BALL BEARING		1
11	588 07 35-01	GEAR HOUSING		1
12	504 11 03-03	GASKET		1
13	505 45 41-01	PINION		1
14	503 25 53-01	NEEDLE BEARING		1
15	725 24 53-71	SCREW EHHM		2
16	574 21 43-03	GEAR HOUSING	Incl. 17	1
17	574 20 30-01	GREASE		1





## MOTOR HOUSING

K 4000 Cut-n-Break, 2018-02

Ref	Part No	Description	Remark	QTY	KIT
1	582 33 94-02	COVER		1	
2	589 53 01-01	SCREW ITXSCT		2	
3	574 35 35-05	SCREW ITXSCM		3	
4	735 11 36-50	SPRING WASHER		4	
5	574 35 35-07	SCREW ITXSCM		1	
6	732 25 14-01	HEXAGON LOCKING NUT		2	
7	501 98 02-01	COUPLER		1	
8	577 38 40-01	CABLE ASSY		1	
9	589 78 68-01	SCREW		1	
10	735 21 24-01	LOCKWASHER		1	
11	582 33 50-01	MOTOR HOUSING		1	
13	589 91 12-02	CARBON BRUSH	120V	1	15
13	589 91 12-01	CARBON BRUSH	230V	1	15
15	581 05 85-05	BRUSH HOLDER	230V	1	
15	581 05 85-06	BRUSH HOLDER	120V	1	
16	505 53 03-07	AIR STREAM DIRECTOR		1	
17	503 21 53-96	SCREW ITXSCM		2	
18	582 58 41-02	STATOR ASSY	100-120V	1	
18	582 58 41-01	STATOR ASSY	230V	1	
19	589 60 93-02	DECAL		1	
20	589 60 95-01	DECAL	US	1	
21	589 60 95-02	DECAL	RoW	1	

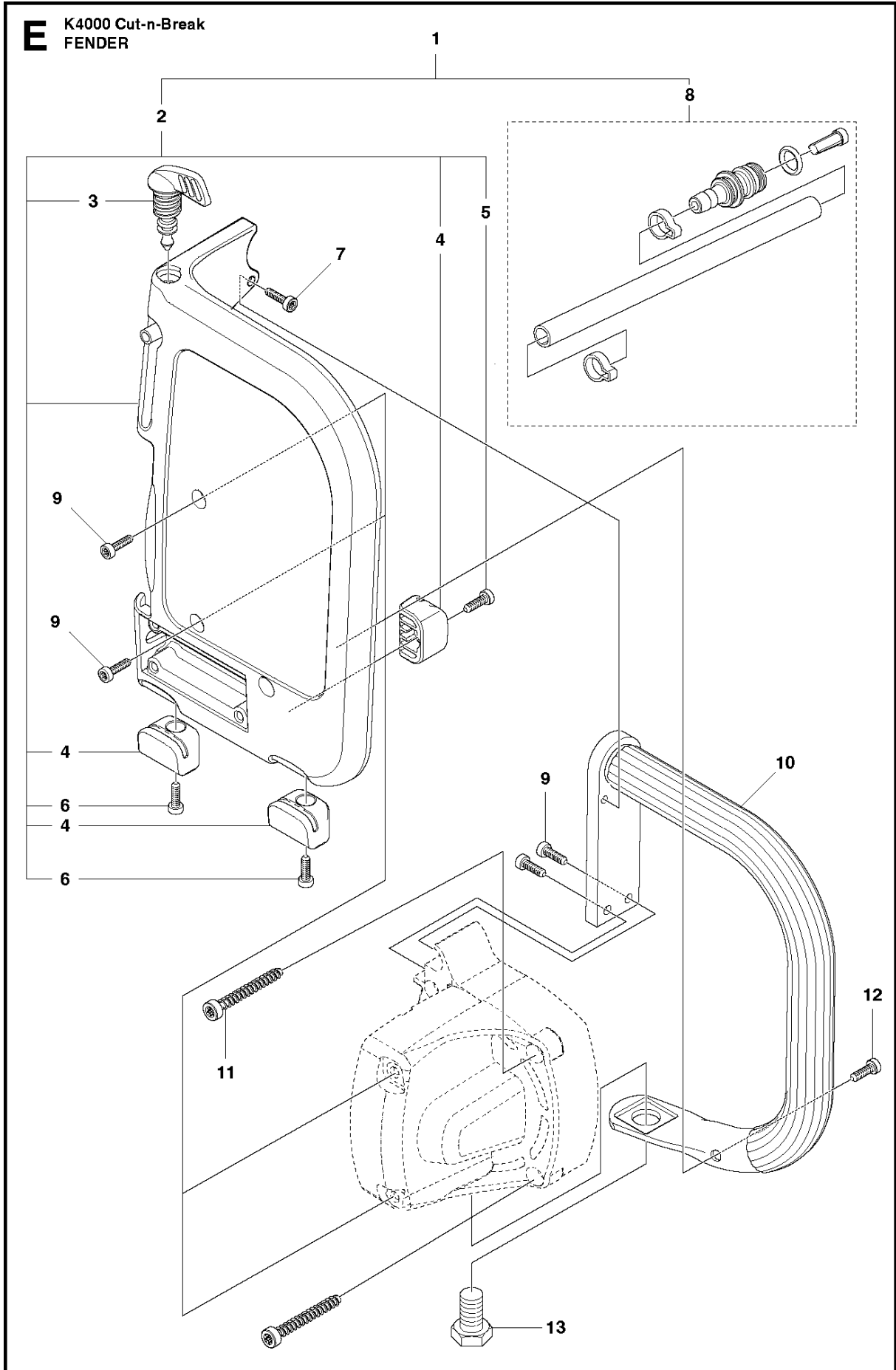

## HANDLE

K 4000 Cut-n-Break, 2018-02

Ref	Part No	Description	Remark	QTY KIT
1	504 61 28-02	FENDER	Incl. 2, 8	1
2	504 61 28-03	FENDER	Incl. 3-6	1
3	505 52 42-01	VALVE SPINDLE		1
4	544 98 32-01	GROUND SUPPORT		3
5	504 90 94-10	SCREW ITXSCT		1
6	504 90 94-14	SCREW ITXSCT		2
7	503 21 53-10	SCREW ITXSCM		1
8	575 51 62-02	HOSE ASSY		1
9	503 21 53-16	SCREW ITXSCM		4
10	540 01 83-01	FRONT HANDLE ASSY		1
11	589 58 33-01	SCREW		4
12	504 90 94-25	SCREW ITXSCT		1
13	531 03 12-76	SCREW		1

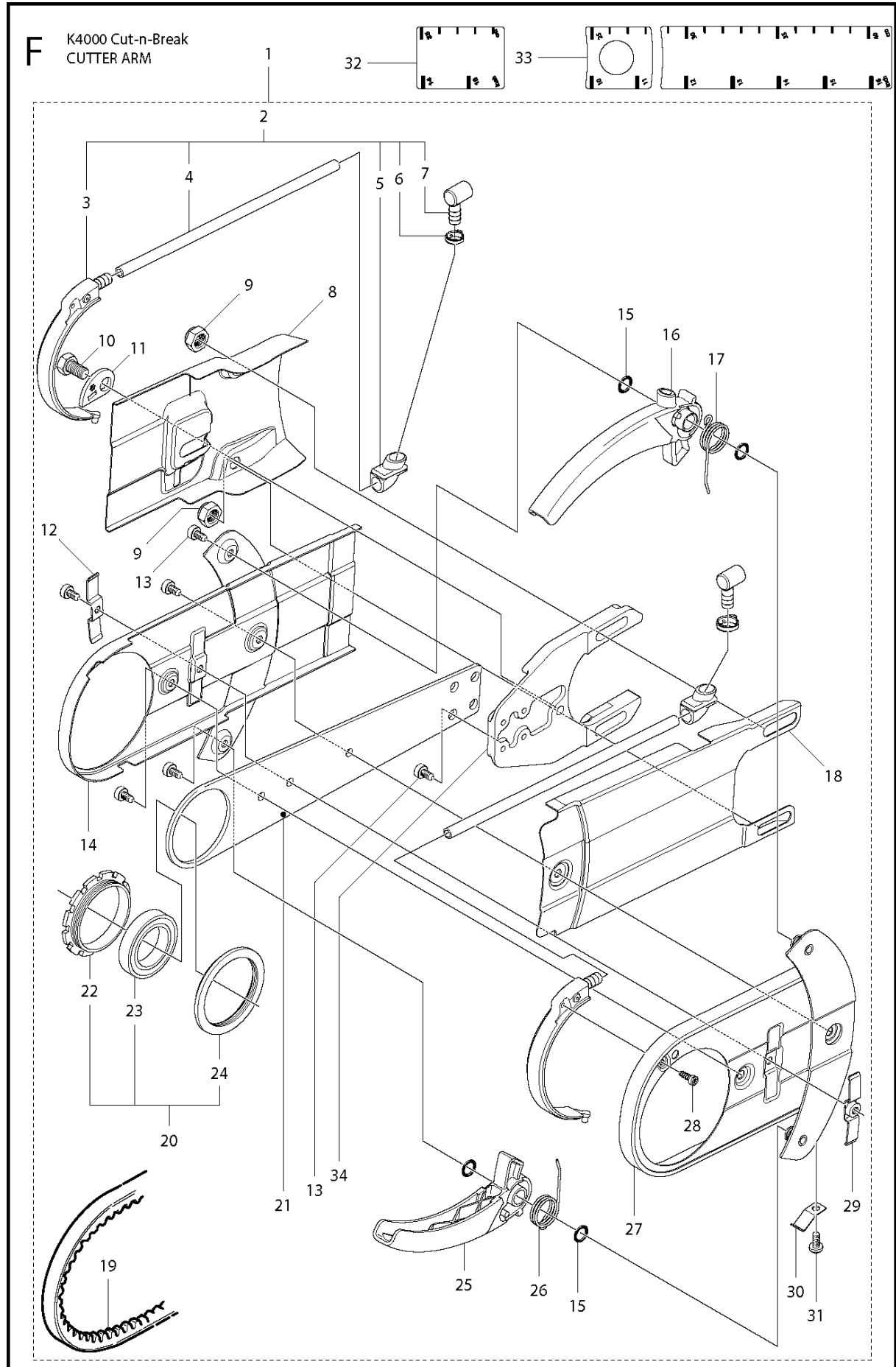

## CUTTER ARM

K 4000 Cut-n-Break, 2018-02

Ref	Part No	Description	Remark	QTY KIT
1	504 61 31-02	CUTTER ARM	Incl. 2 - 34	1
2	544 10 50-05	HOSE	Incl. 3 - 7	1
3	504 87 52-01	SEALING		1
4	581 89 38-02	HOSE		1
5	506 40 57-02	GROMMET		1
6	506 09 56-05	HOSE CLAMP		1
7	506 40 98-02	NIPPLE		1
8	544 95 24-01	BELT GUARD		1
9	731 23 18-01	HEXAGON NUT		2
10	725 24 45-71	SCREW EHHM		1
11	544 42 98-01	ECCENTRIC		1
12	506 40 56-01	DEFLECTION LIMITER		1
13	503 21 53-10	SCREW ITXSCM		9
14	544 42 15-01	BELT GUARD ASSY		1
15	503 26 30-08	O-RING		4
16	506 40 64-03	BLADE GUARD		1
17	506 40 61-01	SPRING		1
18	544 42 14-01	BELT GUARD ASSY		1
19	506 37 27-20	BELT		1
20	593 99 27-01	SERVICE KIT	Incl. 22 - 24	1
21	574 44 75-01	BAR PLATE		1
22	506 40 28-02	BEARING CAGE		1
23	544 10 59-01	BEARING		1
24	506 40 29-02	BUSHING		1
25	506 40 65-02	BLADE GUARD		1
26	506 40 61-02	SPRING		1
27	506 40 46-03	WEAR PROTECTION		1
28	503 21 28-10	SCREW CCRPANT		1
29	506 40 56-02	DEFLECTION LIMITER		1
30	506 40 51-01	STOP		1
31	724 12 84-01	SCREW CRPANM		1
32	505 47 37-01	LABEL		1
33	544 37 44-02	LABEL		1
34	522 47 27-01	BAR BRACKET		1

**G** K4000 CUT-N-BREAK  
CUTTING BLADE

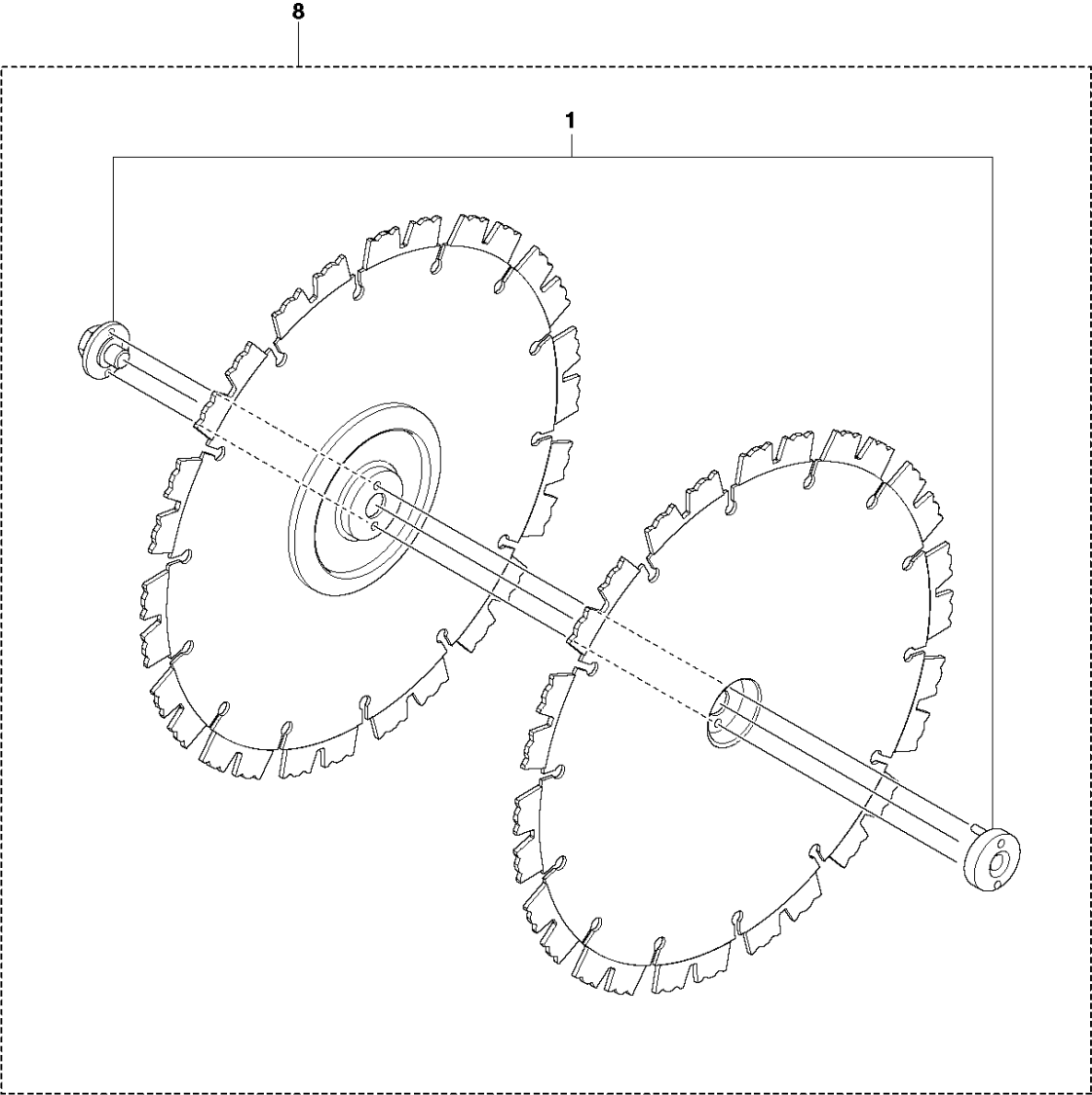

CUTTING BLADE

K 4000 Cut-n-Break, 2018-02

Ref	Part No	Description	Remark	QTY KIT
1	501 00 88-08	SCREW KIT		1
8	574 83 62-01	DIAMOND BLADE	EL10CnB	1
8	574 83 62-02	DIAMOND BLADE	EL35CNB	1
8	574 83 62-03	DIAMOND BLADE	EL70CnB	1

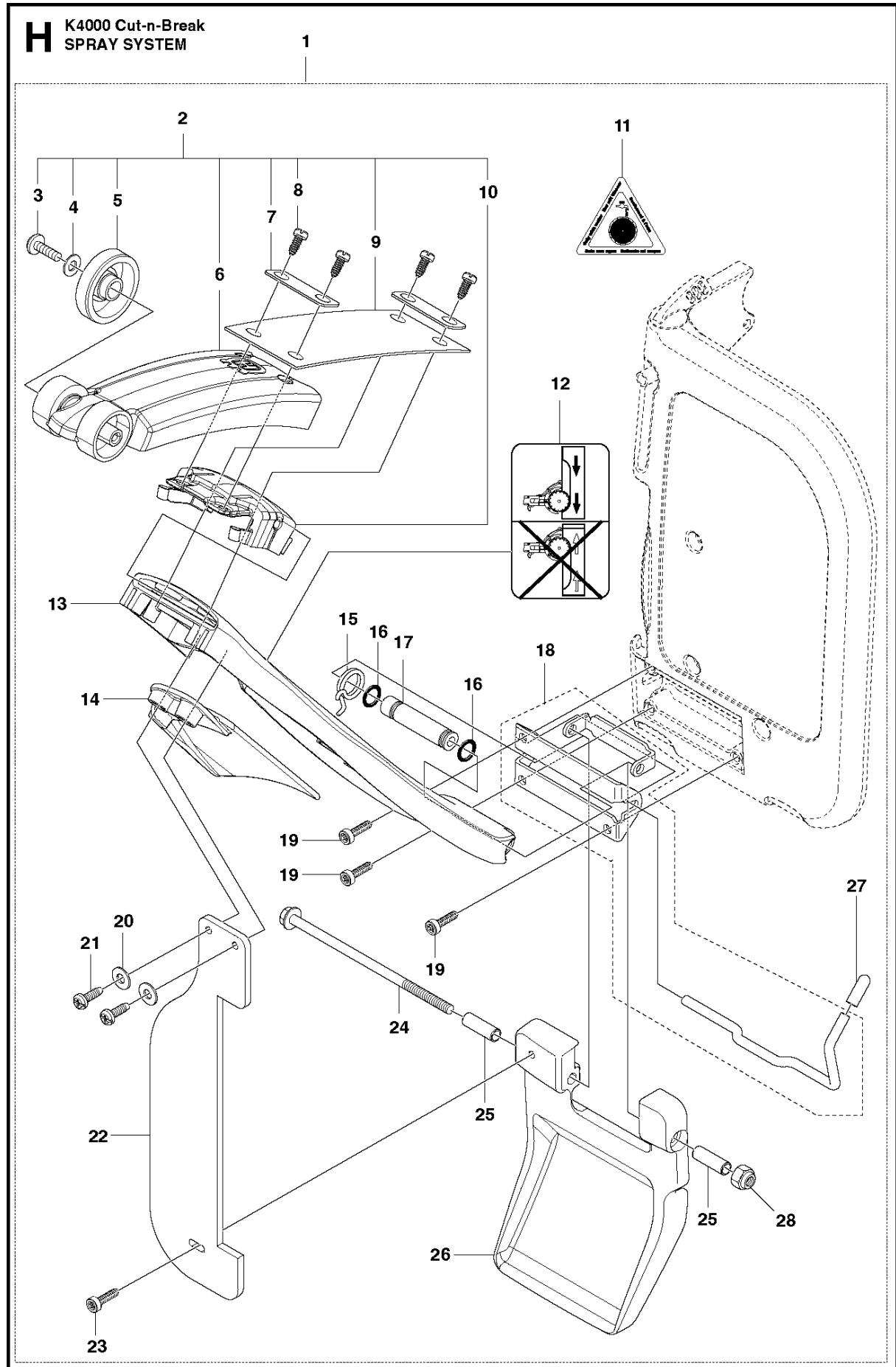



## SPRAY SYSTEM

K 4000 Cut-n-Break, 2018-02

Ref	Part No	Description	Remark	QTY KIT
1	504 61 29-03	SPRAY GUARD	Incl. 2, 11 - 28	1
2	510 05 66-01	SPRAY GUARD	Incl. 3 - 10	1
3	503 21 46-01	SCREW		2
4	734 48 80-01	WASHER		2
5	506 26 22-02	WHEEL		2
6	510 00 72-01	SPRAY GUARD		1
7	510 20 20-01	WASHER		2
8	503 21 27-16	SCREW CRPANT		4
9	510 20 24-01	BAND		1
10	510 00 73-01	GUIDE		1
11	504 79 36-01	LABEL		1
12	522 03 81-01	DECAL		1
13	544 97 60-03	SPRAY GUARD		1
14	504 04 94-01	SPRAY GUARD		1
15	506 40 60-01	SPRING		1
16	740 42 05-00	O-RING		2
17	506 40 37-01	BUSHING		1
18	587 29 30-01	RETAINER		1
19	504 90 94-14	SCREW ITXSCT		3
20	503 23 00-11	WASHER		2
21	503 21 27-13	SCREW CCRPANT		2
22	525 83 37-01	SPRAY GUARD		1
23	510 26 92-16	SCREW ITXSCT		1
24	503 21 53-96	SCREW ITXSCM		1
25	522 55 85-01	GUIDE BUSHING		2
26	505 14 86-01	FENDER		1
27	505 38 88-01	COVER LID		1
28	503 22 24-01	LOCK NUT		1

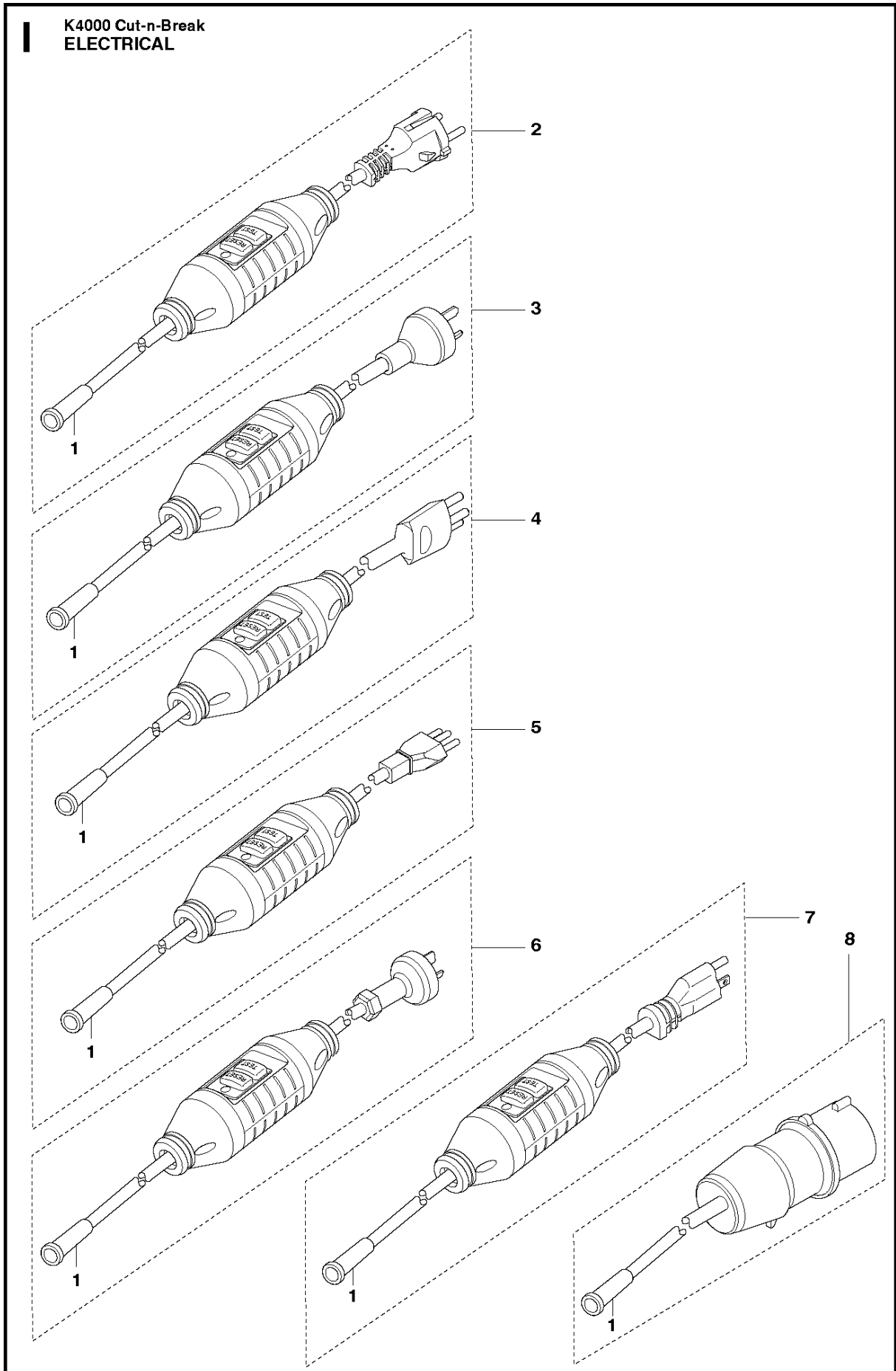

ELECTRICAL

K 4000 Cut-n-Break, 2018-02

Ref	Part No	Description	Remark	QTY KIT
1	575 81 10-01	CABLE SLEEVE		1
2	594 00 56-01	CABLE ASSY	230V PRCD, incl 1	1
3	594 00 56-06	CABLE ASSY	110V PRCD, AU, incl 1	1
4	594 00 56-05	CABLE ASSY	230V PRCD, CH, incl 1	1
5	594 00 56-07	CABLE ASSY	230V PRCD, BR, incl 1	1
6	594 00 56-02	CABLE ASSY	230V PRCD, CN, incl 1	1
7	594 00 56-03	CABLE ASSY	100-120V PRCD, JP, US, incl 1	1
8	593 90 39-01	CABLE ASSY	UK	1

**J** K4000 Cut-n-Break  
TOOLS

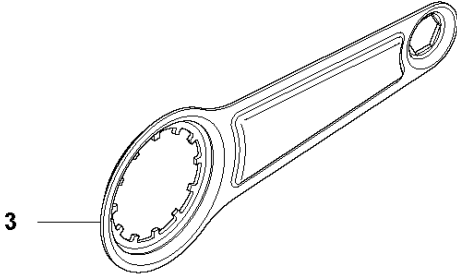
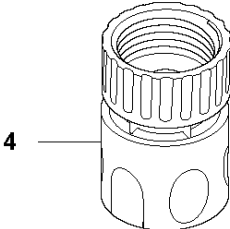
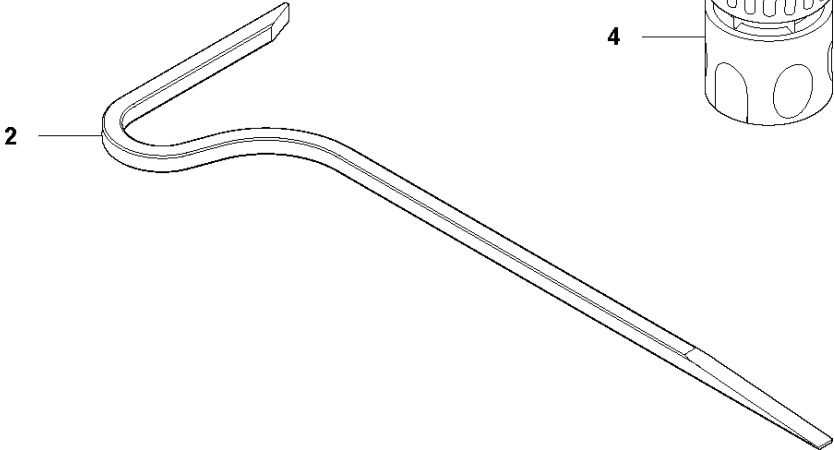
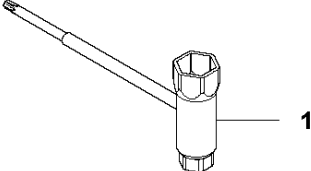

## TOOLS

K 4000 Cut-n-Break, 2018-02

Ref	Part No	Description	Remark	QTY KIT
1	506 38 26-01	TOOL		2
2	544 17 80-03	TOOL		1
3	544 17 81-01	PULLER		1
4	503 26 60-03	COUPLER	USA	1
4	503 26 60-04	COUPLER	RoW	1